



12407 Mukilteo Speedway, Ste. 130, Lynnwood, WA 98087  
 Phone: (425) 322-3170 Fax: (877) 721-6107  
 info@amkspeakers.com www.amkspeakers.com

AMK Commercial Series

## DS82-B / DS82-B-X

Network powered speakers  
 Dante™ Enabled Network Audio  
 8" Coaxial Loudspeaker Assembly  
 (Preliminary)



### Features:

- ♦ Network enabled Loudspeaker by Dante™
- ♦ PoE+ powered without a need for local power.
- ♦ RJ45 connection for audio from PoE+ Ethernet.
- ♦ 8" polypropylene cone with inverted rubber surround.
- ♦ 1" Polyamide dome tweeter
- ♦ Weather and water resistant.
- ♦ Two Channel Audio
- ♦ UL 2043 Listed Enclosure

The AMK DS82-B (**DS82-B-X** for AES67, DDM Ready) is a Dante™ audio network addressable and self-amplified ceiling speaker system. The speaker is powered by PoE+ network switch meaning no external power supply is required.

The speaker includes a Class D amplifier which provides effective use of power. This system will solve the issue of having to provide a separate amplifier or I/O interface for speaker installations.

The system comes with 8" coaxial 40W loudspeaker driver, CX802, that has excellent dispersion, wide bandwidth and a smooth frequency response makes this the top choice for today's overhead commercial applications.

One PoE+ amplified speaker can power a total of (2) speakers, one active and one passive speaker. The passive speaker installed at different zone for different channel of broadcasting.

This assembly can be used in wide range of projects for paging and background music applications. The DS82-B is ideal for hotels, education, hospitals, retail stores, performing art centers, restaurants, airports, houses of worship, and board rooms.

For details on Dante Networking, please visit:

<https://www.audinate.com/resources/networks-switches>

System Specification		AMK Dante Ceiling Speaker Advantage
Frequency Response	100 Hz - 20 kHz (+/- 3dB)	* 2 channels broadcasting system for two separate zones.  * No need to have separate dante enabled amp or I/O interface  * A Single RJ45 connection to main active speaker with two conductor wire connection to each of the passive speakers.  * Highly efficient speaker driver due to barium ferrite magnet.  * Cost effective simple one system solution.
Maximum SPL at 1M	105 dB	
Voice-coil diameter	1."	
Magnet	Barium Ferrite (for high efficiency of the speaker driver)	
Nominal Coverage Angle (500Hz – 4kHz Average)	110° Conical Average	
Audio Input	Dante Audio via Ethernet	
Output Power	10W / Channel (5W per speaker)	
Signal to Noise Ratio	>99dB	
Power consumption	2 Watts Standby, 25 Watts Maximum	
Input connector on active speaker	RJ-45	
Maximum wire length to companion Speakers	300ft (100m) at 16-18AWG	
PoE+	IEEE 802.3at-2009	
Controls	Dante™ controller software	
UL Listed Enclosure	UL 2043	

Physical Speaker Data		Frequency Response
Tweeter	13mm polyamide hard dome	
Woofer Cone	Polypropylene	
Surround Material	Inverted rubber Surround	
Crossover Frequency	5.5 kHz	
Depth	8.25"	
Diameter of the Enclosure	9.25"	
Diameter of the Grille	12.75"	
Enclosure Mounting	Metal Swivel Clamp	
Net Weight of single speaker (Grille, Back Enclosure, and Loudspeaker)	10.0 lbs	
Shipping Weight (2 boxes of 4 speakers)	60.0 lbs	

# CHANNEL ZONING ILLUSTRATION

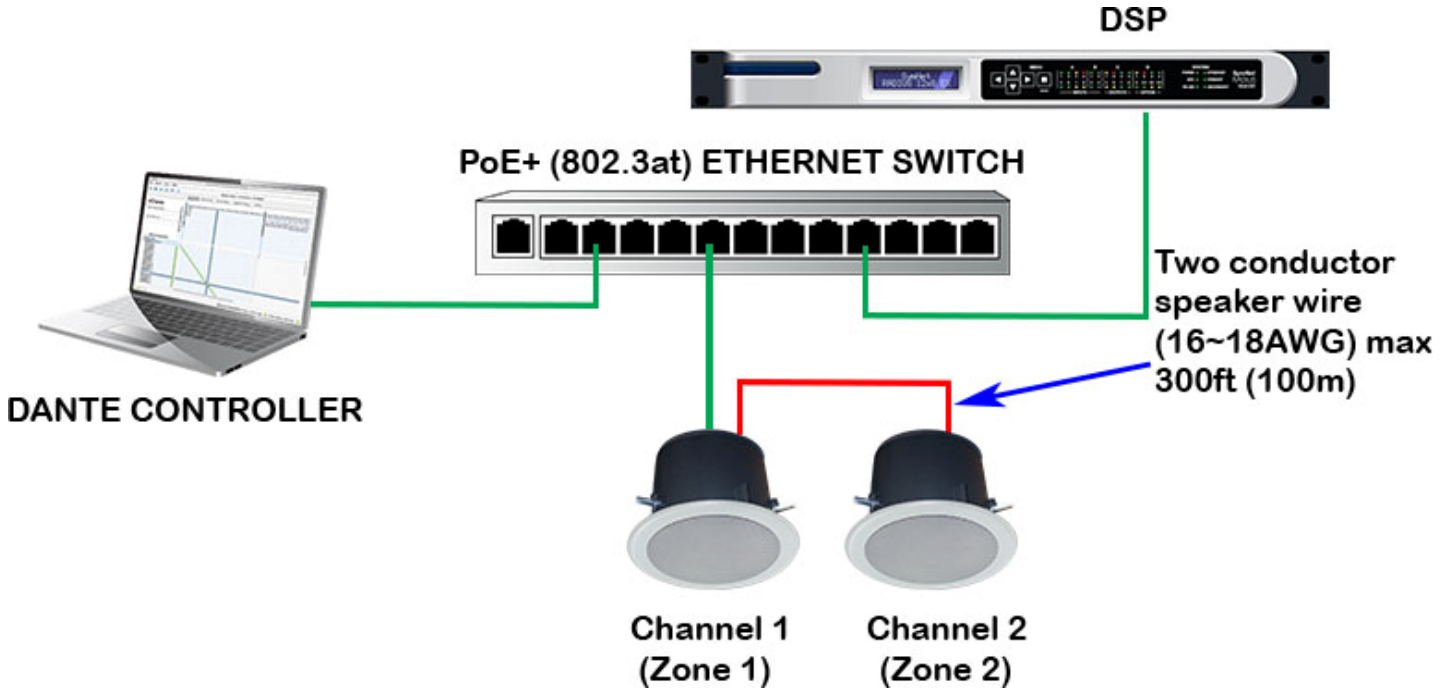

# SPEAKER CONFIGURATION \*

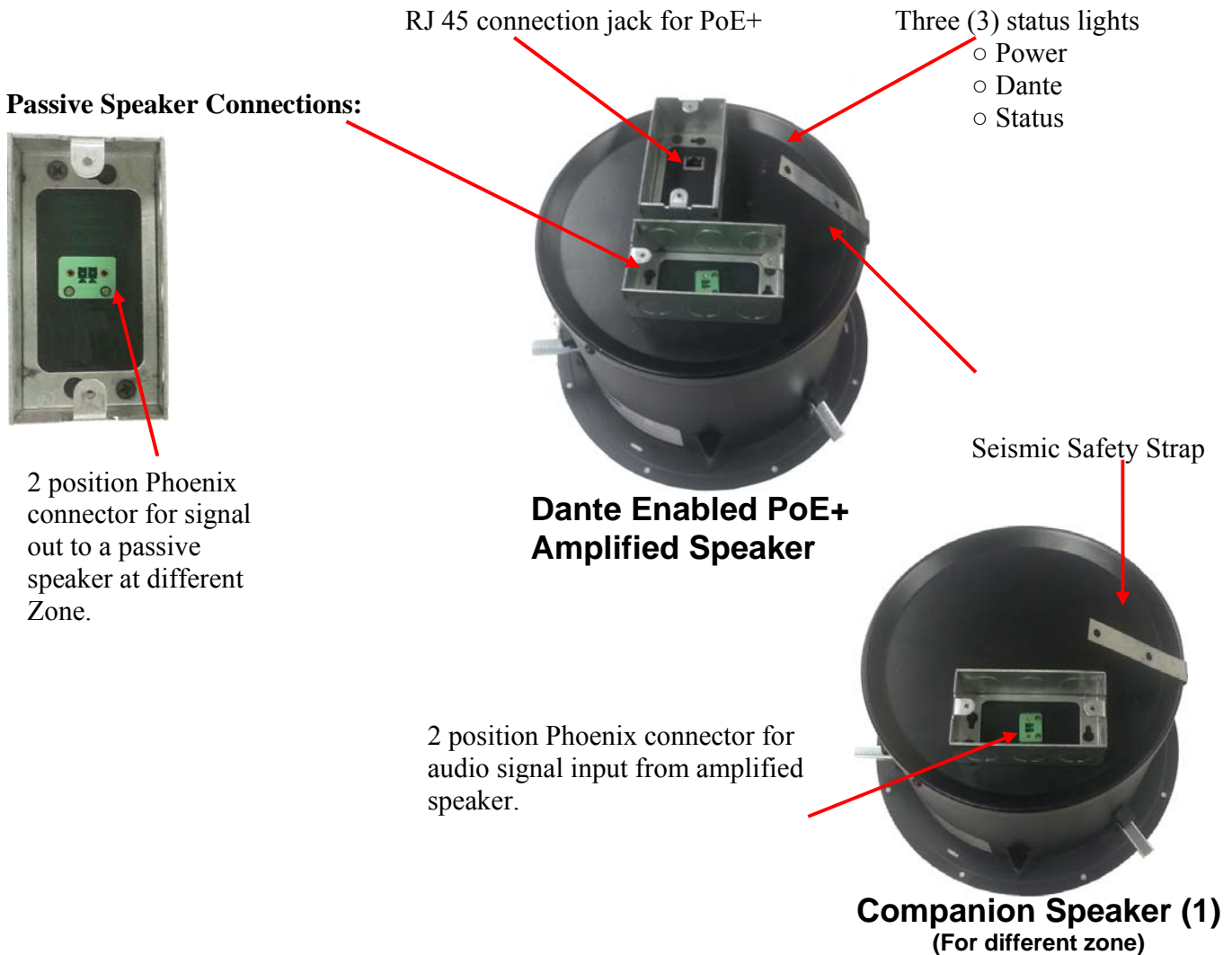

# INSTALLATION SCHEMATICS

Standard Ceiling Tile Bridges  
(Included for all 4 speakers)

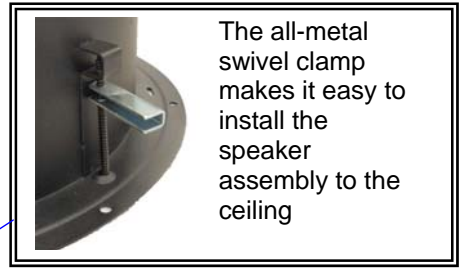
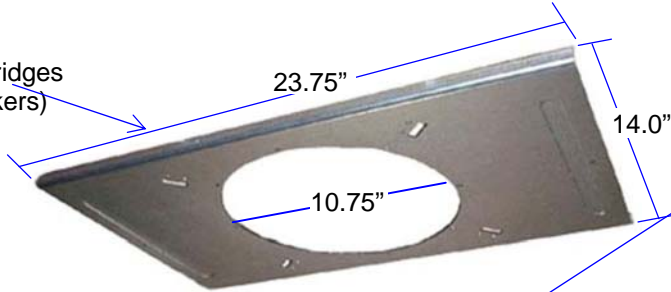

The all-metal swivel clamp makes it easy to install the speaker assembly to the ceiling

Plenum Compatible Back Enclosure for **UL 2043** Listed for Plenum Fire Rating.

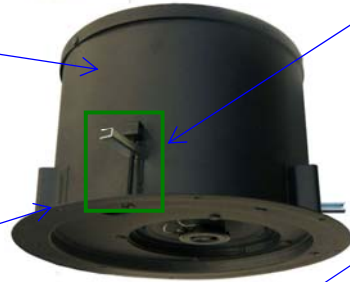

Cardboard Paint Mask (To be discarded after Painting)

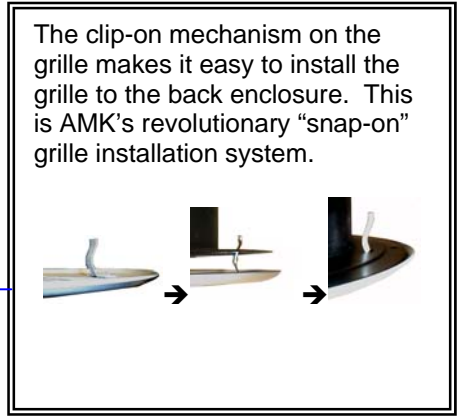

The clip-on mechanism on the grille makes it easy to install the grille to the back enclosure. This is AMK's revolutionary "snap-on" grille installation system.

Guide for alignment of enclosure to tile bridge for grille installation

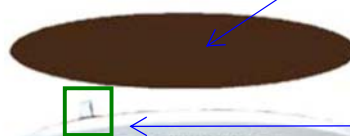

White Perforated Metal Grille

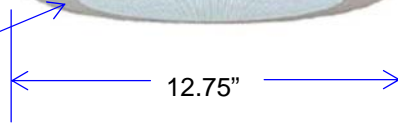

12.75"



For hard lid ceiling installations – Retro fit, (drywall, gypsum, wood or other non-removable material) C-ring, **SACSD**, is available.

Recessed speaker baffle plate

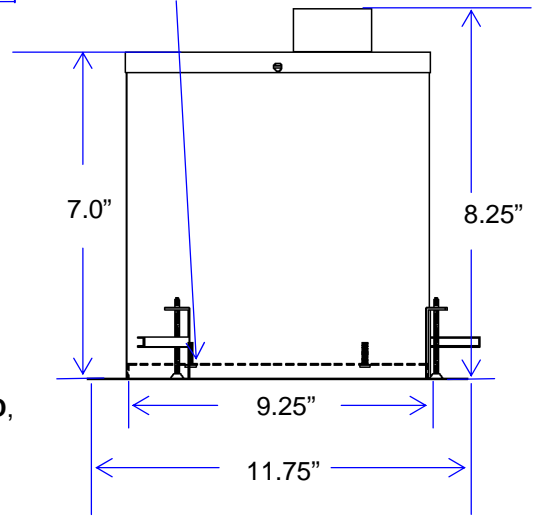

Model	Mounting	Dante	AES 67
DS82-B	Tile Bridge	YES	NO
DS82-B-X	Tile Bridge	YES	YES
DS82-B-S	SACSD Ring	YES	NO
DS82-B-X-S	SACSD Ring	YES	YES

## Architect's & Engineer's Specifications

The powered loudspeaker system shall be **AMK DS82-B (DS82-B-X for AES67, DDM Ready)**. The speaker shall feature Audinate / Dante™ network audio signal that broadcasts 1 channel of audio. The speaker system shall consist of a set of 2 speakers broadcasting different channels of audio for different zones.

The Ethernet network must have PoE+ to provide the power that is needed for the system.

The active unit of the system shall have one RJ-45 jack for network audio connection. Then there shall be (1) one of the two position phoenix type (euro) connection. The connection shall be for the passive speaker at different zone.

The transducer in the loudspeaker system shall be AMK CX 802 coaxial loudspeaker. The woofer shall have a 20 oz. Barium Ferrite magnet. The two reproducer sections shall be coupled through a built-in capacitor bypass crossover. The crossover frequency shall be at 5.5 kHz. The low frequency reproducer shall have 1" (25.4mm) voice coil and the high frequency reproducer shall have 0.51" (13mm) voice coil.

The system shall have a frequency response of 55 Hz- 20 kHz (+/- 5dB). The power handling shall be 40watts at 8 ohm impedance. The sensitivity shall be 91dB at 1watt / 1meter.

The depth of all 2 enclosures shall be 8.25 inches. The rim diameter shall be 11.75". The enclosure diameter shall be 9.25". The depth of the enclosures shall not exceed 8.25". The system shall include 2 tile bridges. The system shall have a metal strap for attachment to a structure for seismic protection.

The total weight of the each of the speaker enclosure, tile bridge, and grille shall not exceed 9.0 lbs.

The loudspeaker system shall be AMK Innovations model **DS82-B (DS82-B-X for AES67, DDM Ready)**.

**Conforms to EIA Standards: RS-276-A, RS-278-B, RS-426-A.**

## Polar Responses

(Measurement done in house)

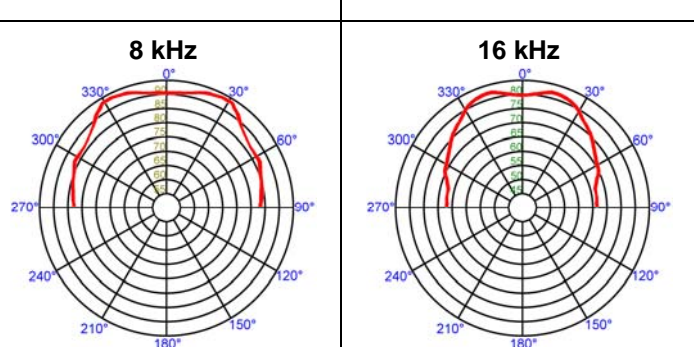
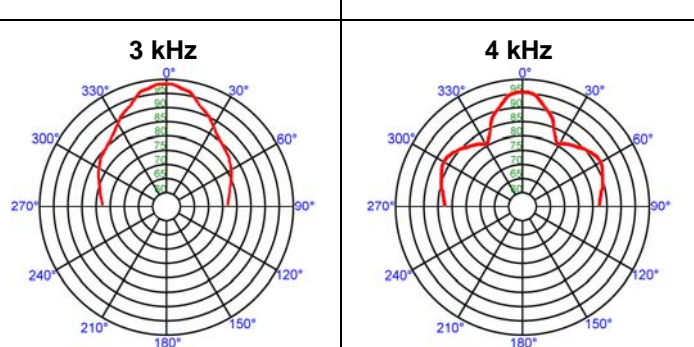
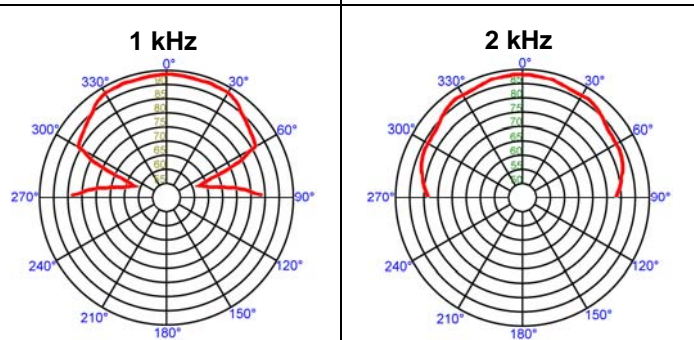
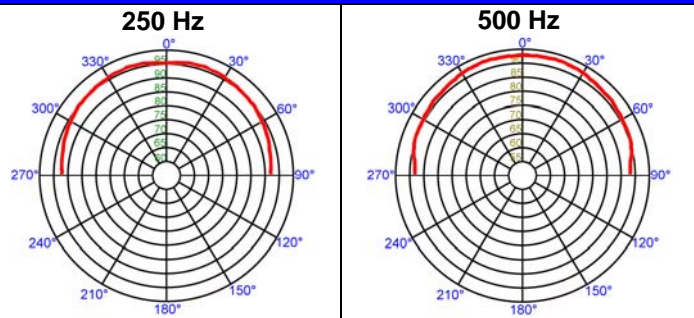

Freq	Deg	Freq	Deg
250 Hz	98°	250 Hz	98°
500 Hz	95°	500 Hz	95°
1 kHz	55°	1 kHz	55°
2 kHz	55°	2 kHz	55°
3 kHz	34°	3 kHz	34°
4 kHz	25°	4 kHz	25°
8 kHz	65°	8 kHz	65°
16 kHz	52°	16 kHz	52°