



Installation Manual  
**DT82-A / DT82-A-X**  
Dante System Network Enabled Speaker

12407 Mukilteo Speedway, Ste. 130  
Lynnwood, WA 98087  
p. 800.438-4026 f. 877.721.8107  
tech@amkspeakers.com  
www.amkspeakers.com

This set up guide contains installation instruction of the AMK DT82-A / DT82-A-X series of AMK's Dante System enabled network self amplified speaker. This speaker is designed to use in plenum rated ceiling spaces and can be dropped into standard square (2' x 2' or 600mm by 600mm) or rectangular (2' x 4" or 600mm by 1200mm) false ceiling tile space with a tile bridge.

### **Important Safety Instructions.**

**WARNING:** May result in serious injury. Installation and service must be performed by authorized personnel only

1. Read these instructions
2. Keep these instructions
3. Heed all warnings
4. Follow all instructions.
5. Do not use this speakers near water
6. Clean only with dry cloth.
7. Do not block any ventilation openings. Install in accordance with manufacturer's instructions.
8. Do not install these speakers near any heat sources such as radiators, heat registers, stoves, or other apparatus (including amplifiers) that produce heat.
9. Use only attachments/accessories specified by manufacturer
10. If the speakers have not been used for some time, unplug the speakers. Or when there is a lightning storms, please unplug the speakers for safety.

### **Parts Check List.**

2x2 lay in PoE+ self amplified network speaker (1)  
2x2 lay in companion speaker (1)  
Handy Box Covers (3)

## For Suspended Ceiling Installations

Remove the ceiling tile from the selected speaker location that is to be cut from the ceiling, and an adjacent ceiling tile for access.

### Installation

1. Make sure that all the power is removed.
2. Remove and cut ceiling tile as shown below. If the tile is 2' x 4', then you will need to cut the tile into half. Install the T-rail crosspiece into the ceiling opening up against the cut tile, as shown below.

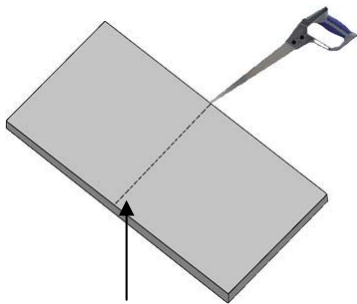

Carefully measure and draw the line at the halfway point.

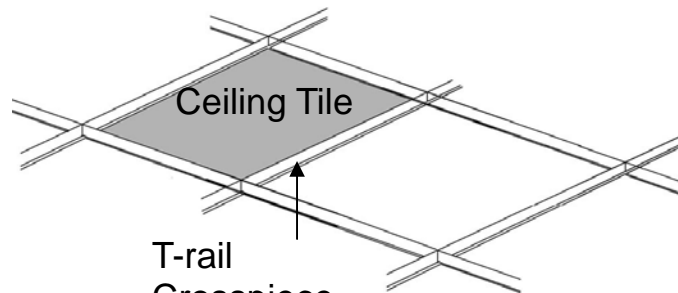

T-rail  
Crosspiece  
needs to be  
installed.

3. Install the T-rail in a rectangular tile – When the ceiling uses rectangular tiles, install the T-rail crosspiece into the ceiling opening up against the cut tile.

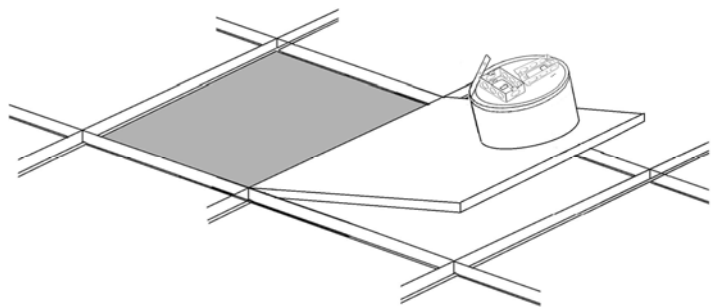

Lay in the speaker appropriately as it is shown above.

4. Connect appropriate cables and plugs. Connect the right plugs for the audio and power into the jacks on the top of the enclosure. Different types of connections are shown on next page.

## Three Light Indicators:

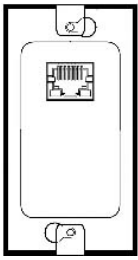

- Power
- Dante
- Status

When RJ45 connection is made, you should be seeing some lights blinking on the right side of the RJ45 connection handy box as shown.

From top to bottom, it will be Power, Dante, and Status.

- Power: This shows the power coming from PoE+ network switch. If there is no power present, then the light will not turn green. The speaker must be running from PoE+ network switch in order to get the green light.
- Dante: This will blink red in the beginning as it is trying to connect with the computer system. When connection is made and Dante signal is confirmed, the light will turn green.
- Status: As the audio signal gets transmitted into the speaker system, the light will blink green as the signals go through.

## Companion Speaker connection.

Connect the audio wire from active speaker to the passive speakers. Punch the one of the knockout on the side of the handy box. After the connection is made, make sure to close the handy box with the cover provided.

A single 2 position phoenix connection inside of the handybox.

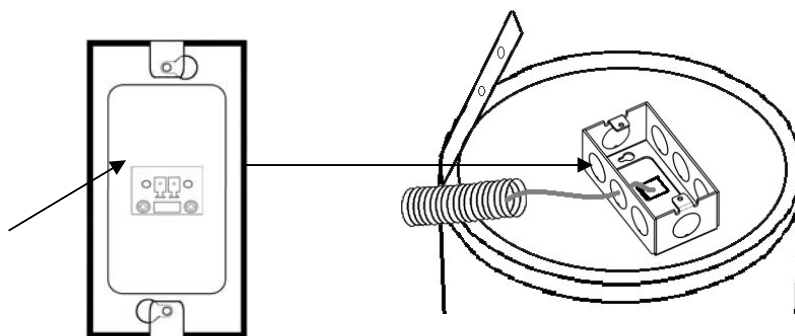

## Main Active Speaker Wire Connection:

Connect the audio wires connecting active speakers to three passive speakers through conduit. Pre terminate the wire and connect the Phoenix plug to the wire. Punch the knockout on the side of the handy box. After the connection is made, make sure to close the handy box with the cover provided.

The audio wires should be a two conductor wire with recommended 18 AWG wire.

Connect the Ethernet signal wires through conduit, terminate with RJ45 connector, punch the one of the knock out where RJ45 jack is located, than plug it into the speaker. After the connection is made, make sure to close the handy box with the cover provided.

A single 2 position phoenix connection inside of the handybox.

Connection to passive speaker for same channel

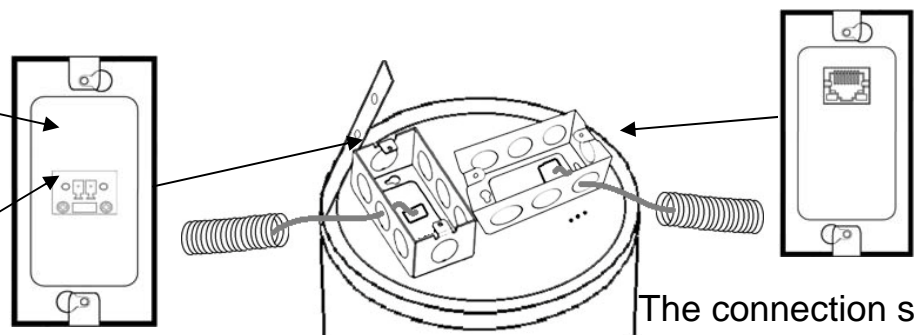

The connection should be made Cat5 or above cable for the Ethernet connection.

## Warranty

The speakers should be not open, altered, tampered without the consulting with AMK, otherwise you will lose the warranty on the speaker. If the speaker is a need for additional support for seismic mounting, please consult with AMK.