



12407 Mukilteo Speedway, Ste. 130, Lynnwood, WA 98087
 Phone: (800) 438-4026 Fax: (877) 721-6107
 info@amkspeakers.com www.amkspeakers.com

AMK Commercial Series

PSA 802-EFS (-P)

Self Amplified 8" Coaxial Loudspeaker Assembly



The **AMK PSA802-EFS** powered speakers feature a 30 watt Class D digital design amplifier, with > 75% efficiency for the main speaker. These units are available as single master speakers or sets with an unpowered companion speaker (**PSA802-EFS-P**). The speaker combines high performance, power handling, and a very smooth response.

The loudspeaker driver, CX802, is one of the few transducers in the commercial sound industry that produces and meets the standards of recording studio. Excellent dispersion, wide bandwidth, and a smooth frequency response make this the top choice for today's overhead commercial applications.

There are wide ranges of the application for this unit, especially in educational markets and corporate boardrooms where direct input of the signal from the processor is desired (i.e., projectors, laptops, or any line level device)

Features:

- * All metal construction, including baffle
- * High performance 8" coaxial loudspeaker with wide dispersion
- * Self powered with 30 watt Class D amplifier
- * **UL Listed (UL 1480, UL 2043) PK-213-8QM Enclosure**

Innovative Features

Each system includes a renowned AMK Coaxial loudspeaker like those already installed in hundreds of locations

Easy to install

- All-metal swivel mounting system allows standard installation of speakers without having to align the enclosure to the tile bridge
- This installation procedure is quick and unique to the industry
- Architecturally pleasing white perforated metal grille that uses a unique metal spring system for a "no visible hardware finished look and the ease of a "snap on" installation

Custom Manufacturing Options

- Custom depth back enclosures are available
- Power supply available internal or external

Safety

- The use of all-metal attachment parts makes for an overall safer installation
- All-metal swivel prevents breakage of swivel during installation
- All-metal swivel mounting system is not easily compromised by fire

Sound

- The plenum compatible back enclosure is designed to maximize the performance of this studio quality speaker

Specifications

Frequency Response	55 Hz - 20 kHz
Voice-coil diameter	1"
Average Beamwidth @ 2 kHz	110 deg.
Magnet Weight	20 oz
Magnet Material	Barium Ferrite
Tweeter	13mm Polyamide Soft Dome
Woofer Cone	Polypropylene
Surround Material	Inverted Rubber
Crossover Frequency	5.5 kHz
Depth of the Enclosure	7 in.
Diameter of the Grille	12.75 in.
Enclosure Mounting	Metal Swivel Clamp

Amplifier Specifications

Amplification	30 watt Class D design amplifier
Amplifier Efficiency	> 75%
Total Harmonic Distortion	< 0.2%
Signal to Noise Ratio	>95dB
Protection	Protected as to short circuit to supply and ground, as well as minimum current
Controls	Input potentiometer level adjustment

FREQUENCY RESPONSE

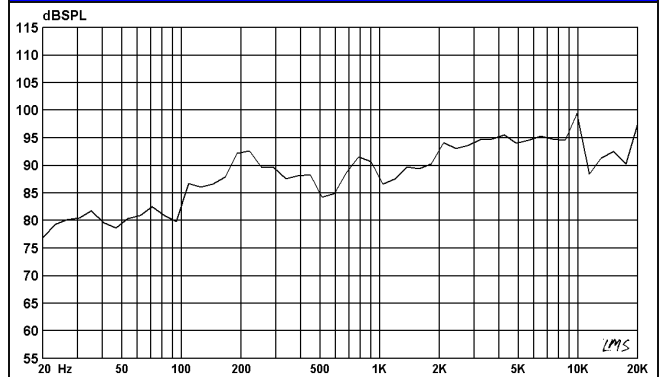

IMPEDANCE CURVE

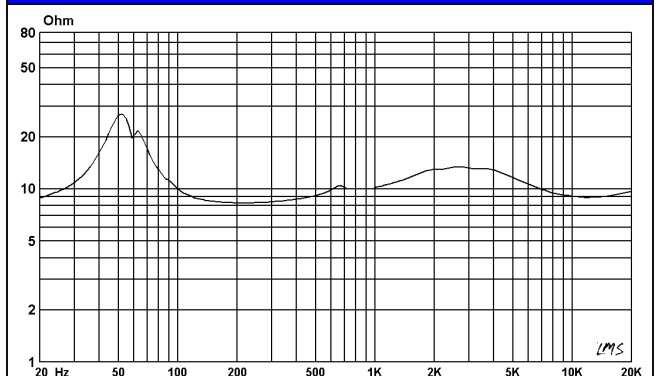

MODEL CONFIGURATION

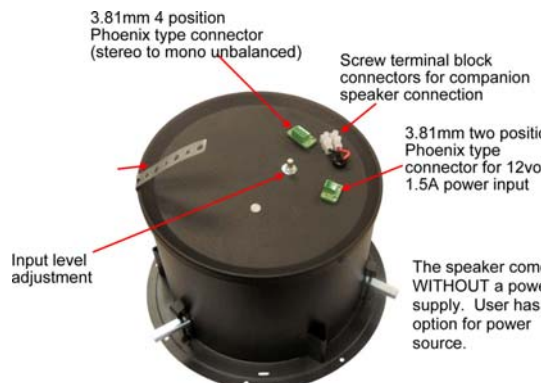
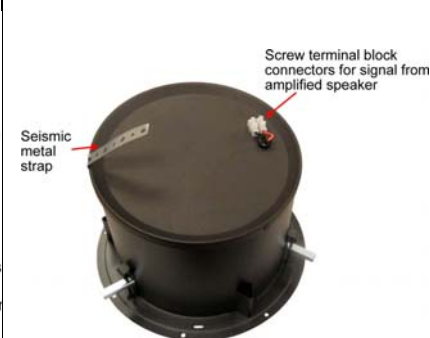
Power Supply	12-24 Volt for external higher amperage multi unit supply (User option for power source)		
Power Connection	3.81mm two position Phoenix type connector		
Input Connection	3.81mm four position Phoenix type connector		
Signal Input	Stereo to Mono unbalanced		
Companion speaker input/output connections (Model No: PSA615-EFS-P)	Screw terminal block connectors		
Input Level Adjustment	Internal	<p>(The PSA615-EFS-P version comes with the companions speaker as a set of 2 speakers)</p>	
Additional Suffixes	The part numbers listed include the TB8R for use with suspended ceilings and speaker Grills For hard lid applications please add either of the following at no additional charge: -SACSD for the metal C ring for retro fit applications. -MD8 For the pre-construction mud ring.		

PSA 802-EFS ILLUSTRATION

Standard Ceiling Tile Bridge

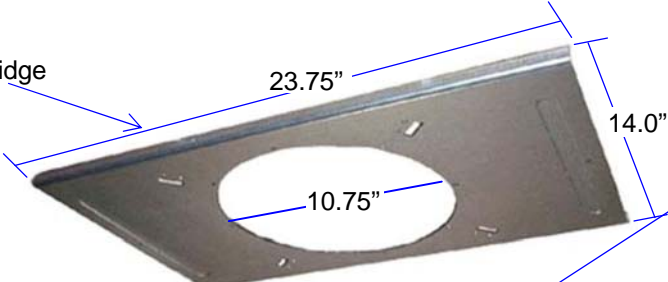

The all-metal swivel clamp makes it easy to install the speaker assembly to the ceiling



Plenum Compatible Back Enclosure
NFPA-70 National Electric Code, UL 1480 and UL 2043, Speakers for Fire Protective Signaling Systems

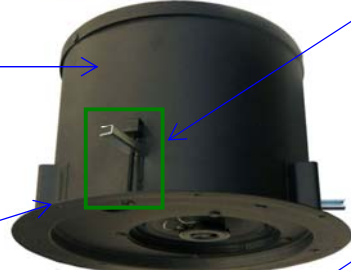

Cardboard Paint Mask (To be discarded after Painting)

The clip-on mechanism on the grille makes it easy to install the grille to the back enclosure. This is AMK's revolutionary "snap-on" grille installation system.



Guide for alignment of enclosure to tile bridge for grille installation



Recessed speaker baffle plate

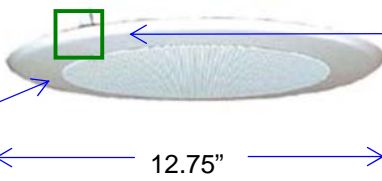

White Perforated Metal Grille



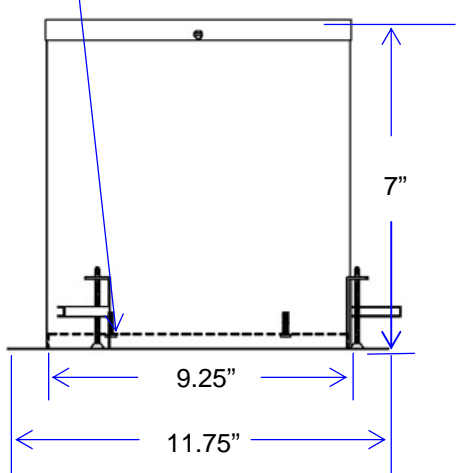

Architect's & Engineer's Specifications

The powered loudspeaker system shall be **AMK PSA 802-EFS (-P)**. The speaker shall feature a 30watt Class D design amplifier, with >75% efficiency for the speaker. The powered speaker systems shall be one amplified speaker with option of one other companion speaker.

The loudspeaker system shall have a white metal round grille with a mounting spring tab snaps into the rim of the enclosure.

The powered unit of the system shall have one 3.81mm four position phoenix type connector for unbalanced audio input. The input level shall be control by the internal potentiometer. The power connection shall be a 3.81mm two position phoenix type connector. The system shall be powered by user's choice of 12-24volt for external higher amperage multi unit power supply.

The transducer in the loudspeaker system shall be AMK CX 802 coaxial loudspeaker. The woofer shall have a 40 oz. (1.13 Kg) Barium Ferrite magnet. The two reproducer sections shall be coupled through a built-in capacitor bypass crossover. The crossover frequency shall be at 5.5 kHz. The low frequency reproducer shall have 1" (25.4mm) voice coil and the high frequency reproducer shall have 0.51" (13mm) voice coil.

The system shall have a frequency response of 55 Hz- 20 kHz (+/- 5dB). The power handling shall be 40watts at 8 ohm impedance. The sensitivity shall be 91dB at 1watt / 1meter.

The depth of the enclosures shall be 7 inches. The rim diameter shall be 11.75". The enclosure diameter shall be 9.25". The depth of the enclosures shall not exceed 11.75". The system shall include a tile bridges. The system shall have a metal strap for attachment to the structure for seismic protection.

The total weight of the each unit system shall not exceed 10.0 lbs.

The loudspeaker system shall be AMK Innovations model **PSA 802-EFS**.

Conforms to EIA Standards: RS-276-A, RS-278-B, RS-426-A

Polar Responses

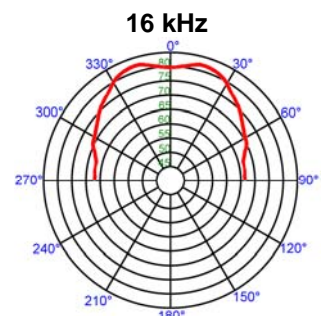
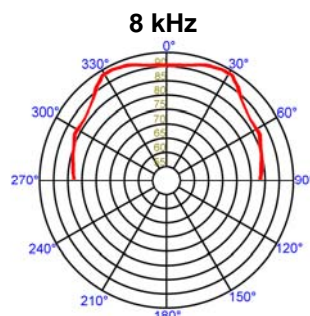
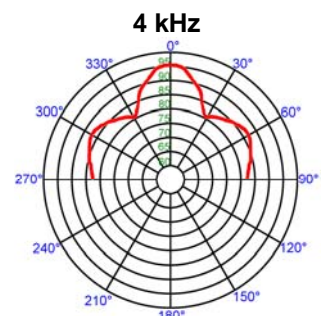
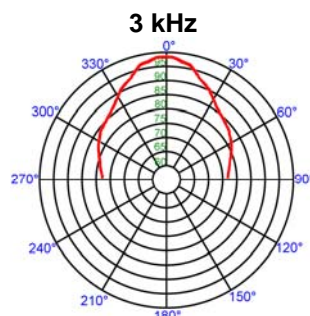
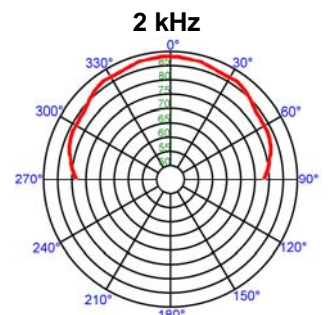
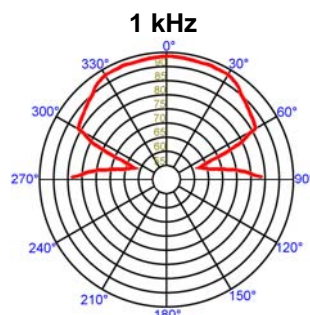
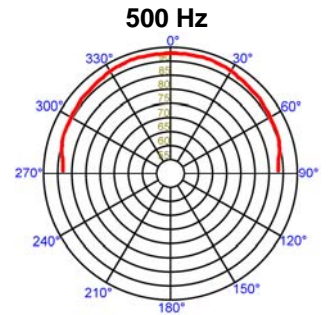
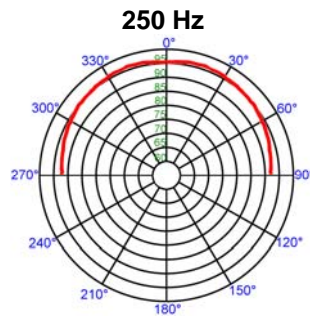

Freq	Deg	Q	DldB
250 Hz	98°	5.1	7.1
500 Hz	95°	5.7	7.5
1 kHz	55°	9.9	10.0
2 kHz	55°	8.2	9.2
3 kHz	34°	14.4	11.6
4 kHz	25°	18.0	12.6
8 kHz	65°	5.1	7.1
16 kHz	52°	6.9	8.4