



12407 Mukilteo Speedway, Ste. 130, Lynnwood, WA 98087
 Phone: (800) 438-4026 Fax: (877) 721-6107
 info@amkspeakers.com www.amkspeakers.com

AMK Commercial Series
QSA 615-MD2

Self Amplified 6.5" Coaxial Loudspeaker Assembly



The **AMK QSA615-MD2** powered speakers feature a 30 watt class D digital design amplifier, with > 75% efficiency for the main speaker. This unit is a quarto system of 4 speakers, one powered speaker and three companion speakers. The speaker combines high performance, power handling, and a very smooth response.

The loudspeaker driver, CX602, is one of the few transducers in the commercial sound industry that produces and meets the standards of recording studio. Excellent dispersion, wide bandwidth, and a smooth frequency response make this the top choice for today's overhead commercial applications.

There are wide ranges of the application for this unit, especially in educational markets and corporate boardrooms where direct input of the signal from the processor is desired (i.e., projectors, laptops, or any line level device)

Features:

- * All metal construction, including baffle
- * High performance 6½" coaxial loudspeaker with wide dispersion
- * Self powered with 20 watt Class D amplifier
- * **UL Listed (UL 1480, UL 2043) PK-213-6 Enclosure**

Innovative Features

Each system includes a renowned AMK Coaxial loudspeaker like those already installed in hundreds of locations

Easy to install

- All-metal swivel mounting system allows standard installation of speakers without having to align the enclosure to the tile bridge
- This installation procedure is quick and unique to the industry
- Architecturally pleasing white perforated metal grille that uses a unique metal spring system for a "no visible hardware finished look and the ease of a "snap on" installation

Custom Manufacturing Options

- Custom depth back enclosures are available
- Power supply available internal or external

Safety

- The use of all-metal attachment parts makes for an overall safer installation
- All-metal swivel prevents breakage of swivel during installation
- All-metal swivel mounting system is not easily compromised by fire

Sound

- The plenum compatible back enclosure is designed to maximize the performance of this studio quality speaker

Specifications

Frequency Response	65 Hz - 20 kHz
Voice-coil diameter	1"
Average Beamwidth @ 2 kHz	144 deg.
Magnet Weight	13 oz
Magnet Material	Barium Ferrite
Tweeter	13mm Polyamide Soft Dome
Woofer Cone	Polypropylene
Surround Material	Inverted Rubber
Crossover Frequency	5.0 kHz
Depth of the Enclosure	10 in.
Diameter of the Grille	12.75 in.
Enclosure Mounting	Metal Swivel Clamp

FREQUENCY RESPONSE

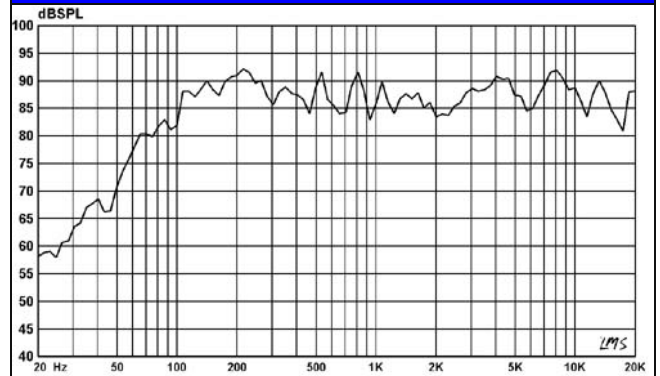

IMPEDANCE CURVE

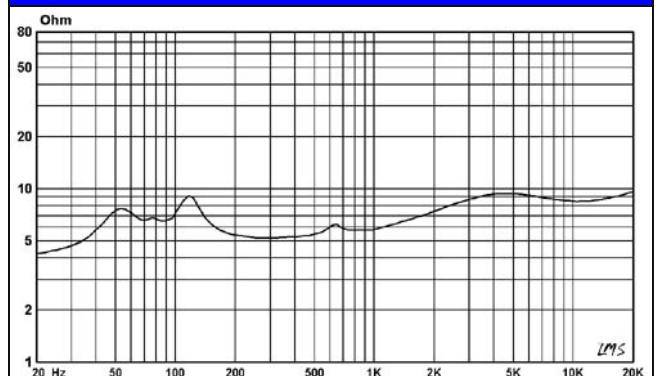

Amplifier Specifications

Amplification	30 watt class D design amplifier
Amplifier Efficiency	> 75%
Total Harmonic Distortion	< 0.2%
Signal to Noise Ratio	>95dB
Protection	Protected as to short circuit to supply and ground, as well as minimum current
Controls	Input potentiometer level adjustment

MODEL CONFIGURATION

(2) 3.5mm stereo mini jacks
(Unbalanced stereo signal
combined into mono)

Screw terminal block
connectors for companion
speaker connection

3.81mm two position
Phoenix type
connector for 12volt
1.5A power input

Screw terminal block
connectors for signal from
amplified speaker

Seismic
metal
strap

Input level
adjustment

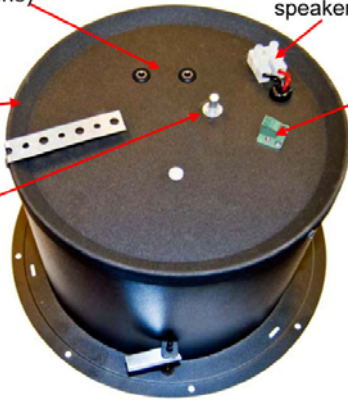

The speaker
comes with one
screw mount with
the eyebolt for
secure mount to
the power outlet.
This is light weight,
24VDC 1.0A power
supply.

Seismic
metal
strap



Powered Speaker

Companion Speaker
(3) units are included

Power Supply	External 12Volt w/ Screw Terminal	Signal Input	Stereo to Mono unbalanced
Power Connection	3.81mm two position Phoenix type connector	Companion speaker input/output connections	Screw terminal block connectors
Input Connection	(2) 3.5mm stereo mini jacks (Unbalanced stereo signal combined into mono)	Input Level Adjustment	Internal
Additional Suffixes	The part numbers listed include the TB8R for use with suspended ceilings and speaker Grills For hard lid applications please add either of the following at no additional charge: -SACSD for the metal C ring for retro fit applications. -MD8 For the pre-construction mud ring.		

Wiring Diagram

All the speakers are connected in parallel

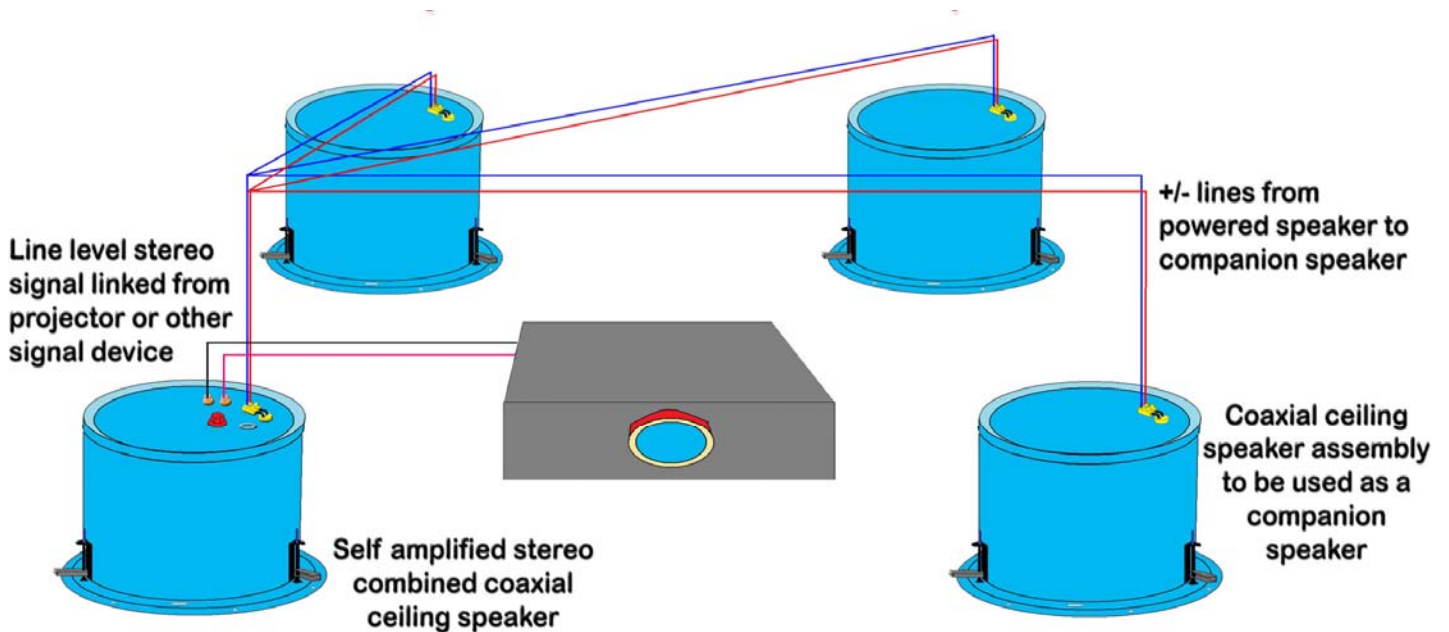

QSA 615-MD2 ILLUSTRATION

Standard Ceiling Tile Bridge
Treated with non conductive
paint material to inhibit
flow of electrical current
on the ceiling grid to
the main speaker
enclosure

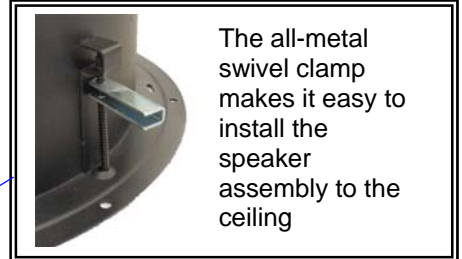
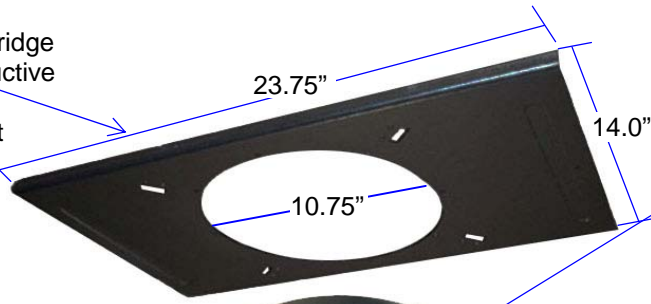

The all-metal
swivel clamp
makes it easy to
install the
speaker
assembly to the
ceiling

Plenum Compatible
Back Enclosure
NFPA-70 National
Electric Code, **UL 1480**
and **UL 2043**, Speakers
for Fire Protective
Signaling Systems

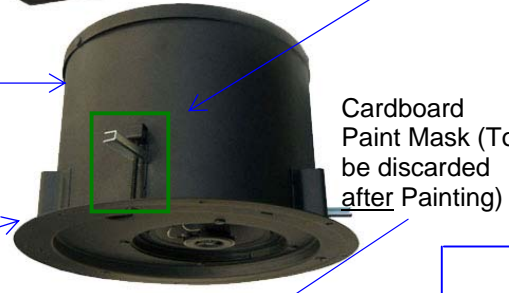

Cardboard
Paint Mask (To
be discarded
after Painting)

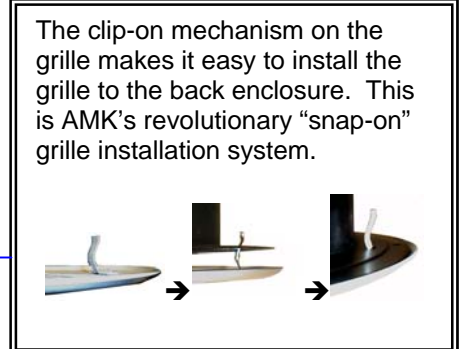

The clip-on mechanism on the
grille makes it easy to install the
grille to the back enclosure. This
is AMK's revolutionary "snap-on"
grille installation system.

Guide for alignment of
enclosure to tile bridge
for grille installation



Recessed speaker baffle plate

White Perforated
Metal Grille

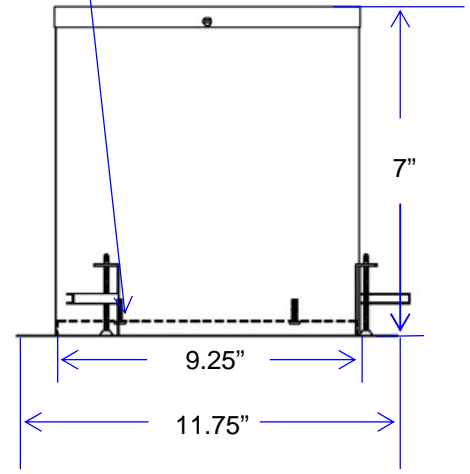
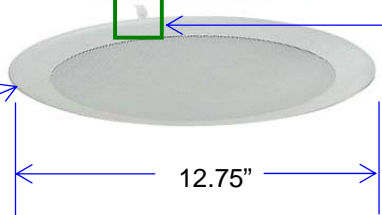

12.75"

7"

9.25"

11.75"

Architect's & Engineer's Specifications

Polar Responses

The powered loudspeaker system shall be **AMK QSA 615-MD-2**. The speaker shall feature a 30 watt Class D design amplifier, with >75% efficiency for the speaker. The powered speaker systems shall be one amplified speaker with three companion speakers.

The loudspeaker system shall have a white metal round grille with a mounting spring tab snaps into the rim of the enclosure.

The powered unit of the system shall have two 3.5mm stereo mini jacks for unbalanced audio stereo signal combined into mono audio input. The input level shall be control by the internal potentiometer. The power connection shall be a 3.81mm two position phoenix type connector. The system shall have 12 volt 1.5 Amps screw mount power supply.

The loudspeaker unit in the system shall be of the coaxial type with an 6.5" woofer of polypropylene, an inverted rubber surround, and a 1" polyamide soft dome tweeter mounted on a post. The transducer in the loudspeaker system shall be AMK CX 602 coaxial loudspeaker. The woofer shall have a 13 oz. (369g) Barium Ferrite magnet. The two reproducer sections shall be coupled through a built-in capacitor bypass crossover.

The crossover frequency shall be at 5.0 kHz. The low frequency reproducer shall have 1" (25.4mm) voice coil and the high frequency reproducer shall have 0.51" (13mm) voice coil. The system shall have a frequency response of 65 Hz- 20 kHz (+/- 5dB). The sensitivity shall be 91dB at 1watt / 1meter.

The depth of the each enclosures shall be 7 inches. The rim diameter shall be 11.75". The enclosure diameter shall be 9.25". The depth of the each enclosures shall not exceed 11.75". The system shall include a tile bridges. The system shall have a metal strap for attachment to the structure for seismic protection.

The total weight of the each unit system shall not exceed 10.0 lbs.

The loudspeaker system shall be AMK Innovations model **QSA 615-MD-2**.

Conforms to EIA Standards: RS-276-A, RS-278-B, RS-426-A

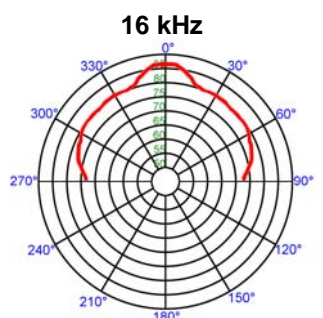
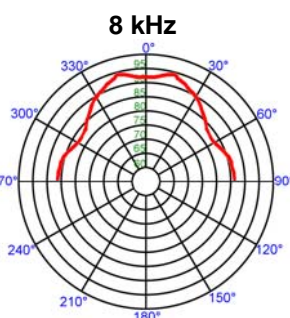
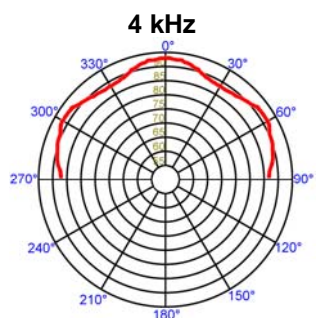
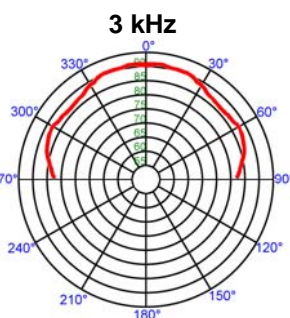
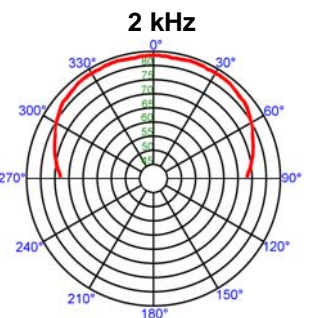
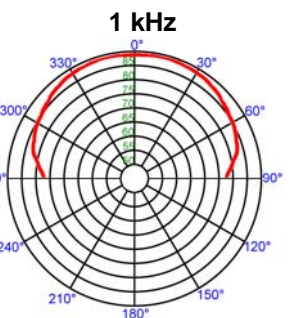
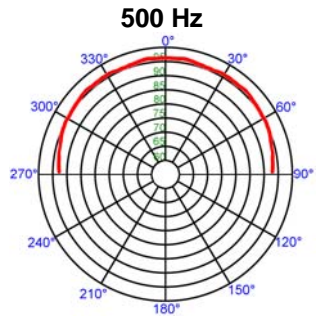
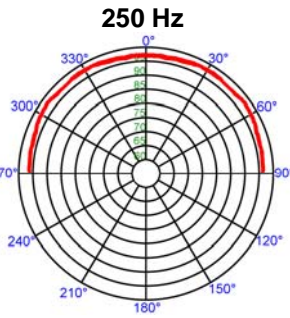

Freq	Deg	Q	DldB
250 Hz	100°	3.8	5.8
500 Hz	96°	4.8	6.8
1 kHz	79°	6.8	8.3
2 kHz	72°	6.7	8.2
3 kHz	66°	9.2	9.6
4 kHz	86°	8.4	9.2
8 kHz	40°	7.1	8.5
16 kHz	16°	15.3	11.8