



12407 Mukilteo Speedway, Ste. 130, Lynnwood, WA 98087  
 Phone: (800) 438-4026 Fax: (877) 721-6107  
 info@amkspeakers.com www.amkspeakers.com

AMK Commercial Series  
**QSA 802-EPM**

Self Amplified 8" Coaxial Loudspeaker Assembly



The **AMK QSA802-EPM** powered speakers feature a 40 watt Class D digital design amplifier, with > 75% efficiency for the main speaker. This unit is a quarto system of 4 speakers, one powered speaker and three companion speakers. The speaker combines high performance, power handling, and a very smooth response.

The loudspeaker driver, CX802, is one of the few transducers in the commercial sound industry that produces and meets the standards of recording studio. Excellent dispersion, wide bandwidth, and a smooth frequency response make this the top choice for today's overhead commercial applications.

There are wide ranges of the application for this unit, especially in educational markets and corporate boardrooms where direct input of the signal from the processor is desired (i.e., projectors, laptops, or any line level device)

**Features:**

- \* All metal construction, including baffle
- \* High performance 6½" coaxial loudspeaker with wide dispersion
- \* Self powered with 20 watt Class D amplifier
- \* **UL Listed (UL 1480, UL 2043) PK-213-6 Enclosure**

**Innovative Features**

Each system includes a renowned AMK Coaxial loudspeaker like those already installed in hundreds of locations

Easy to install

- All-metal swivel mounting system allows standard installation of speakers without having to align the enclosure to the tile bridge
- This installation procedure is quick and unique to the industry
- Architecturally pleasing white perforated metal grille that uses a unique metal spring system for a "no visible hardware finished look and the ease of a "snap on" installation

Custom Manufacturing Options

- Custom depth back enclosures are available
- Power supply available internal or external

Safety

- The use of all-metal attachment parts makes for an overall safer installation
- All-metal swivel prevents breakage of swivel during installation
- All-metal swivel mounting system is not easily compromised by fire

Sound

- The plenum compatible back enclosure is designed to maximize the performance of this studio quality speaker

**Specifications**

<b>Frequency Response</b>	55 Hz - 20 kHz
<b>Voice-coil diameter</b>	1"
<b>Average Beamwidth @ 2 kHz</b>	110 deg.
<b>Magnet Weight</b>	20 oz
<b>Magnet Material</b>	Barium Ferrite
<b>Tweeter</b>	13mm Polyamide Soft Dome
<b>Woofer Cone</b>	Polypropylene
<b>Surround Material</b>	Inverted Rubber
<b>Crossover Frequency</b>	5.5 kHz
<b>Depth of the Enclosure</b>	7 in.
<b>Diameter of the Grille</b>	12.75 in.
<b>Enclosure Mounting</b>	Metal Swivel Clamp

**FREQUENCY RESPONSE**

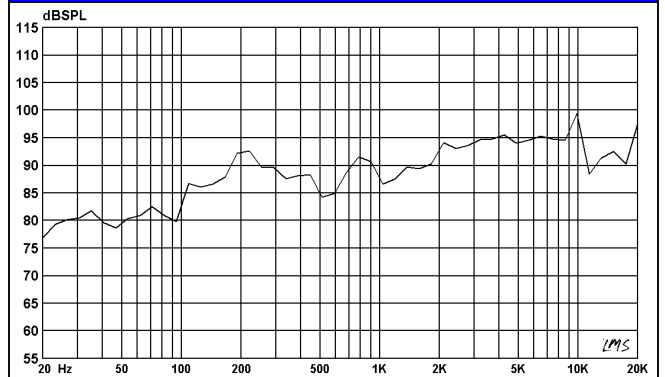

**IMPEDANCE CURVE**

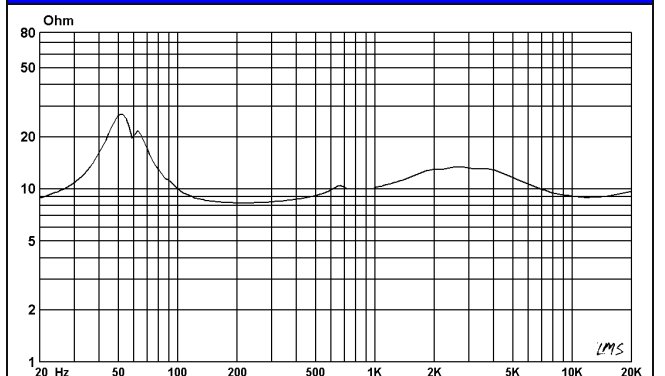

**Amplifier Specifications**

<b>Amplification</b>	40 watt Class D design amplifier
<b>Amplifier Efficiency</b>	> 75%
<b>Total Harmonic Distortion</b>	< 0.2%
<b>Signal to Noise Ratio</b>	>95dB
<b>Protection</b>	Protected as to short circuit to supply and ground, as well as minimum current
<b>Controls</b>	Input potentiometer level adjustment

## MODEL CONFIGURATION

One RCA phono jack  
(One unbalanced input)

Screw terminal block  
connectors for companion  
speaker connection

3.81mm two position  
Phoenix type connector  
for 12volt 1.5A power  
input

The speaker comes  
WITHOUT a power  
supply. User has an  
option for power  
source.

Seismic  
metal  
strap

Input level  
adjustment



**Powered Speaker**

Screw terminal block  
connectors for signal from  
amplified speaker

Seismic  
metal  
strap



**Companion Speaker**  
(3) units are included

<b>Power Supply</b>	12-24 Volt for external higher amperage multi unit supply (User option for power source)	<b>Signal Input</b>	One unbalanced Input
<b>Power Connection</b>	3.81mm two position Phoenix type connector	<b>Companion speaker input/output connections</b>	Screw terminal block connectors
<b>Input Connection</b>	One RCA phono jack	<b>Input Level Adjustment</b>	Internal
<b>Additional Suffixes</b>	Stereo to Mono unbalanced		

## Wiring Diagram

All the speakers are connected in parallel

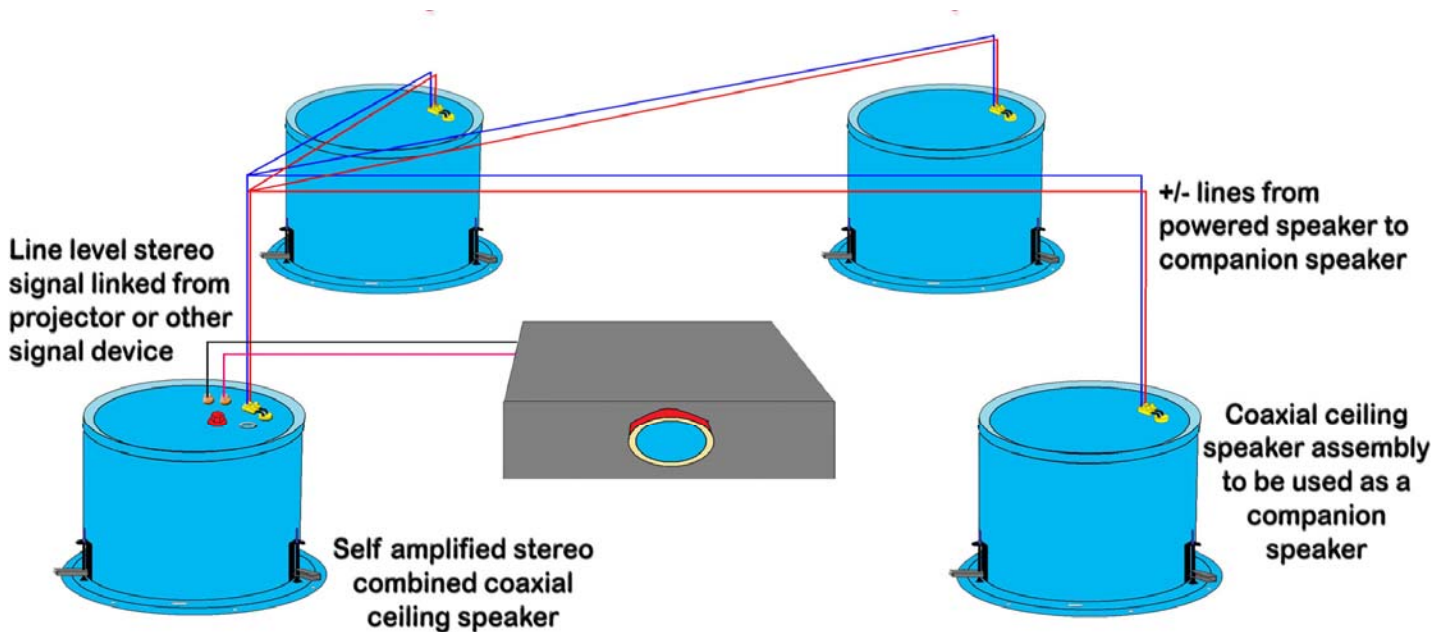

# QSA 802-EPM ILLUSTRATION

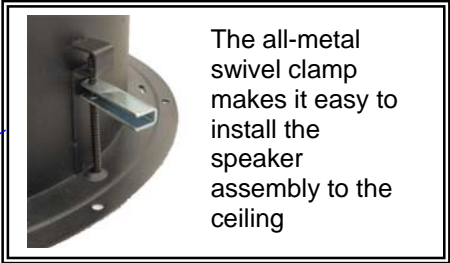
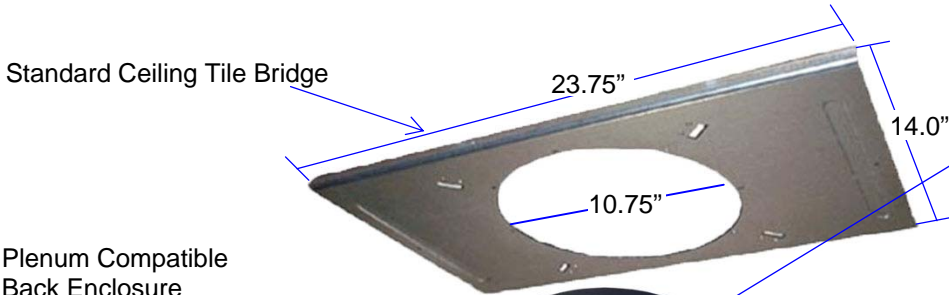

Plenum Compatible Back Enclosure  
**NFPA-70** National  
 Electric Code, **UL 1480**  
 and **UL 2043**, Speakers  
 for Fire Protective  
 Signaling Systems

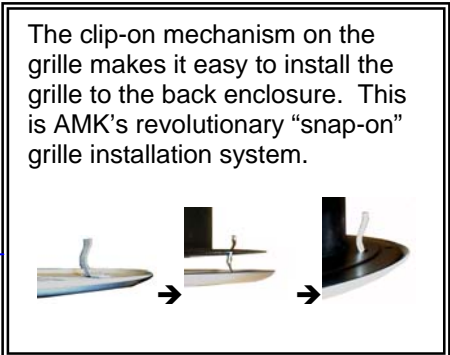
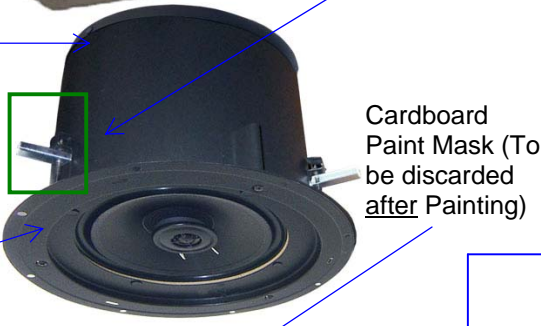

Guide for alignment of enclosure to tile bridge for grille installation

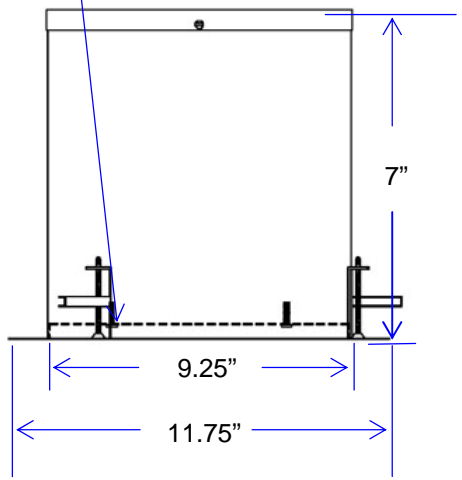

White Perforated Metal Grille

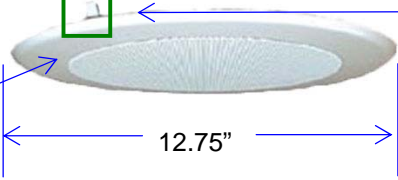

## Architect's & Engineer's Specifications

## Polar Responses

The powered loudspeaker system shall be **AMK QSA 802-EPM**. The speaker shall feature a 40watt Class D design amplifier, with >75% efficiency for the speaker. The powered speaker systems shall be one amplified speaker with three companion speakers.

The loudspeaker system shall have a white metal round grille with a mounting spring tab snaps into the rim of the enclosure.

The powered unit of the system shall have one RCA phono jack for unbalanced audio input. The input level shall be control by the internal potentiometer. The power connection shall be a 3.81mm two position phoenix type connector. The system shall be powered by user's choice of 12-24volt for external higher amperage multi unit power supply.

The transducer in the loudspeaker system shall be AMK CX 802 coaxial loudspeaker. The woofer shall have a 40 oz. (1.13 Kg) Barium Ferrite magnet. The two reproducer sections shall be coupled through a built-in capacitor bypass crossover. The crossover frequency shall be at 5.5 kHz. The low frequency reproducer shall have 1" (25.4mm) voice coil and the high frequency reproducer shall have 0.51" (13mm) voice coil.

The system shall have a frequency response of 55 Hz- 20 kHz (+/- 5dB). The power handling shall be 40watts at 8 ohm impedance. The sensitivity shall be 91dB at 1watt / 1meter.

The depth of the each enclosures shall be 7 inches. The rim diameter shall be 11.75". The enclosure diameter shall be 9.25". The depth of the each enclosures shall not exceed 11.75". The system shall include a tile bridges. The system shall have a metal strap for attachment to the structure for seismic protection.

The total weight of the each unit system shall not exceed 10.0 lbs.

The loudspeaker system shall be AMK Innovations model **QSA 802-EPM**.

**Conforms to EIA Standards: RS-276-A, RS-278-B, RS-426-A**

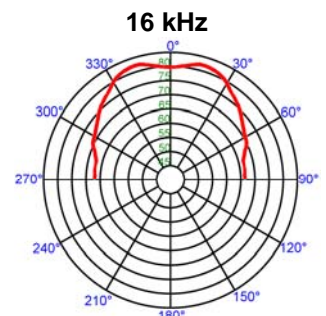
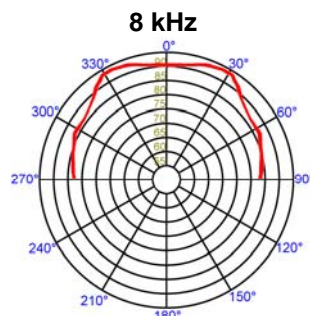
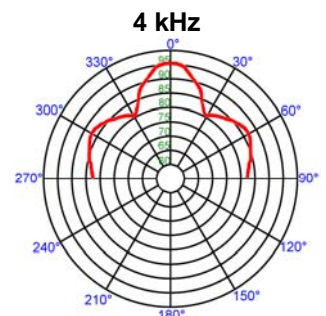
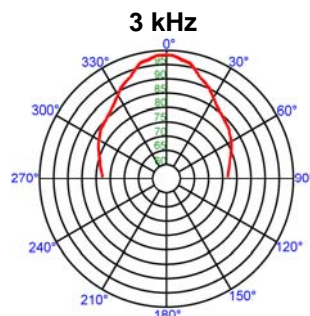
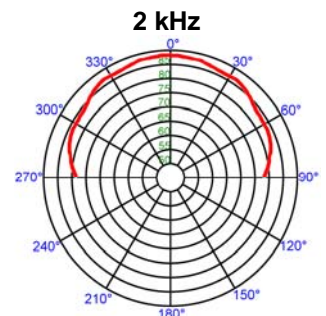
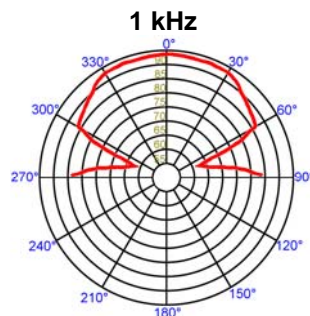
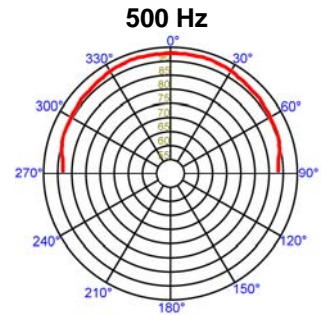
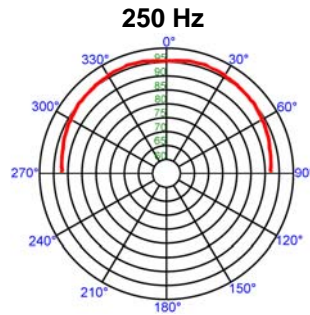

Freq	Deg	Q	DldB
250 Hz	98°	5.1	7.1
500 Hz	95°	5.7	7.5
1 kHz	55°	9.9	10.0
2 kHz	55°	8.2	9.2
3 kHz	34°	14.4	11.6
4 kHz	25°	18.0	12.6
8 kHz	65°	5.1	7.1
16 kHz	52°	6.9	8.4